

LIGHT

LIGHT CLAMPS TO DISPLAY BY TIGHTENING THUMBSCREW

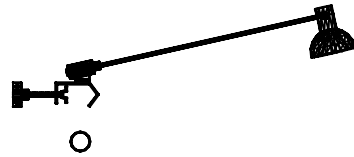

MONITOR MOUNT

MONITOR MOUNTS CLIP ONTO DISPLAY

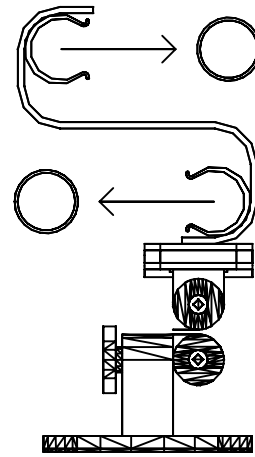

PENINSULA COUNTER

BILL OF MATERIALS

#	QTY	DESCRIPTION
X	2	SUPPORT LEG
PC1	1	COUNTER TOP

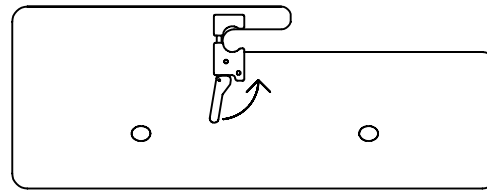

ASSEMBLY OF PENINSULA COUNTER:

- 1) PLUG X ONTO STUDS OF BASE PLATE
- 2) SET PC1 ON TOP OF X'S
- 3) CLOSE LEVER ON BOTTOM OF COUNTER TO MAKE CONNECTION WITH DISPLAY

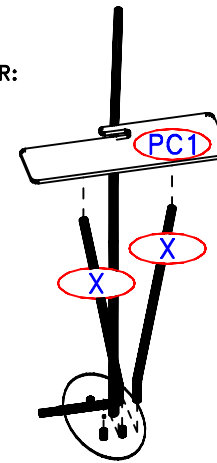

SMALL COUNTER

BILL OF MATERIALS

#	QTY	DESCRIPTION
C1	1	LEFT END SUPPORT FRAME
C3	1	RIGHT END SUPPORT FRAME
C11	1	FRONT BOTTOM SUPPORT BAR
C12	1	FRONT TOP SUPPORT FRAME
C13	1	BOTTOM DOOR FRAME TRACK
C14	1	TOP DOOR FRAME TRACK
C15	1	BOTTOM SHELF
C16	1	MIDDLE SHELF
C17	1	DOOR LEFT
C18	1	DOOR RIGHT
C19	1	COUNTER TOP

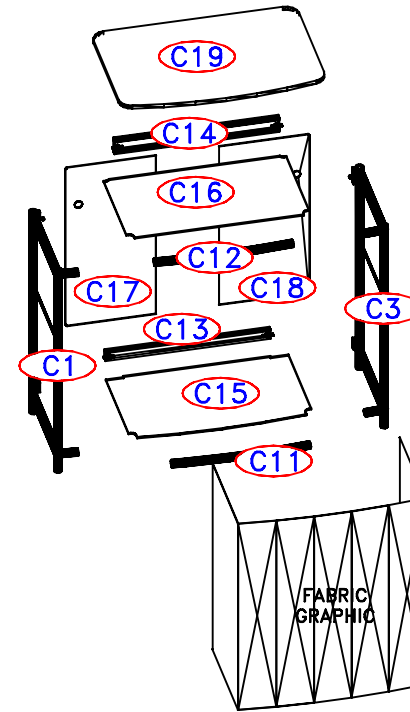

ASSEMBLY OF COUNTER:

- 1) PLUG C11 INTO C1
- 2) PLUG C11 INTO C3
- 3) PLUG C12 INTO C1 AND C3
- 4) ATTACH C13 AND C14 TO EXTRUSION ON TOP AND BOTTOM OF C1 AND C3 BY PLACING CONNECTOR IN GROOVE TIGHTENING THUMBSCREWS
- 5) ATTACH FABRIC GRAPHIC AROUND FRAME WORK OF COUNTER WITH HOLES IN FABRIC GOING OVER EXTENDED RIVETS
- 6) SET C15 AND C16 IN PLACE
- 7) PUT C17 AND C18 INTO GROOVE OF C14 AND LIFT UP AND THEN SET DOWN INTO GROOVE OF C13
- 8) PLACE COUNTER TOP IN PLACE WITH RECESSED HOLES IN COUNTER FITTING OVER FRAME

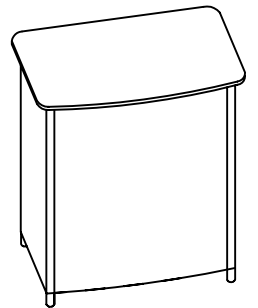

PLACARDS

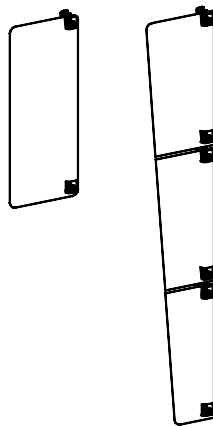

PLEX. SHELF

PLEX. SHELVES CLIP ONTO DISPLAY

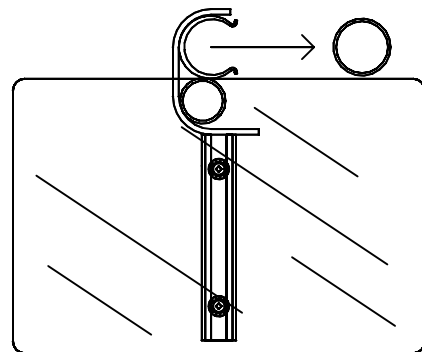

PODIUM

BILL OF MATERIALS

#	QTY	DESCRIPTION
P1	1	BASE PLATE
P2	4	SUPPORT LEG/SHELF STUD
P3	1	COUNTER TOP
P4	1	PLEX. SHELF

ASSEMBLY OF PODIUM:

- 1) PLUG P2 (X4) ONTO STUDS OF P1
- 2) PLUG P2 (X4) INTO RECESSED HOLES IN BOTTOM OF COUNTER TOP, P4
- 3) SLIDE P3 DOWN POLES UNTIL IT STOPS ON STUDS OF P2'S

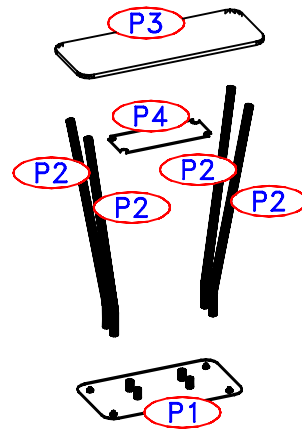

LARGE COUNTER

BILL OF MATERIALS

#	QTY	DESCRIPTION
C1	1	LEFT END SUPPORT FRAME
C2	1	FRONT BOTTOM SUPPORT BAR
C3	1	RIGHT END SUPPORT FRAME
C4	1	FRONT TOP SUPPORT FRAME
C5	1	BOTTOM DOOR FRAME TRACK
C6	1	TOP DOOR FRAME TRACK
C7	1	BOTTOM SHELF
C8	1	MIDDLE SHELF
C9	1	DOOR LEFT
C10	1	DOOR RIGHT
C10	1	COUNTER TOP

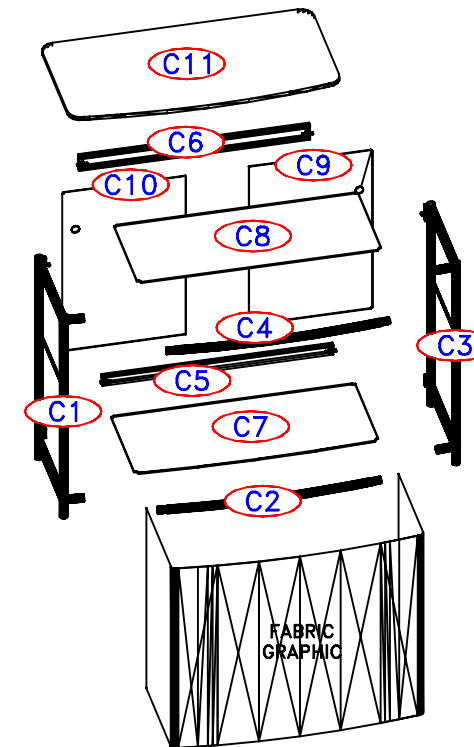

ASSEMBLY OF COUNTER:

- 1) PLUG C2 INTO C1
- 2) PLUG C2 INTO C3
- 3) PLUG C4 INTO C1 AND C3
- 4) ATTACH C5 AND C6 TO EXTRUSION ON TOP AND BOTTOM OF C1 AND C3 BY PLACING CONNECTOR IN GROOVE TIGHTENING THUMBSCREWS
- 5) ATTACH FABRIC GRAPHIC AROUND FRAME WORK OF COUNTER WITH HOLES IN FABRIC GOING OVER EXTENDED RIVETS
- 6) SET C7 AND C8 IN PLACE
- 7) PUT C9 AND C10 INTO GROOVE OF C6 AND LIFT UP AND THEN SET DOWN INTO GROOVE OF C5
- 8) PLACE COUNTER TOP IN PLACE WITH RECESSED HOLES IN COUNTER FITTING OVER FRAME

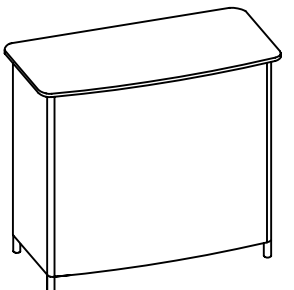

PLACARD ASSEMBLY/ATTACHMENT

FIRST ATTACH BARCKET(S) TO PLACARD

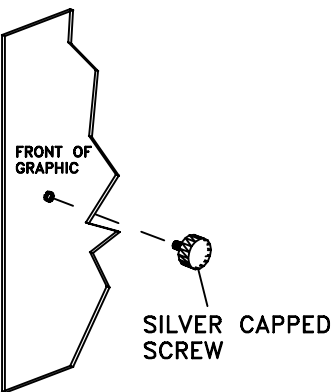

SECOND SNAP BRACKETS/ PLACARD ONTO DISPLAY

SILVER CAPPED SCREW